

EQUINOX

SpectraPix Batten

User Manual

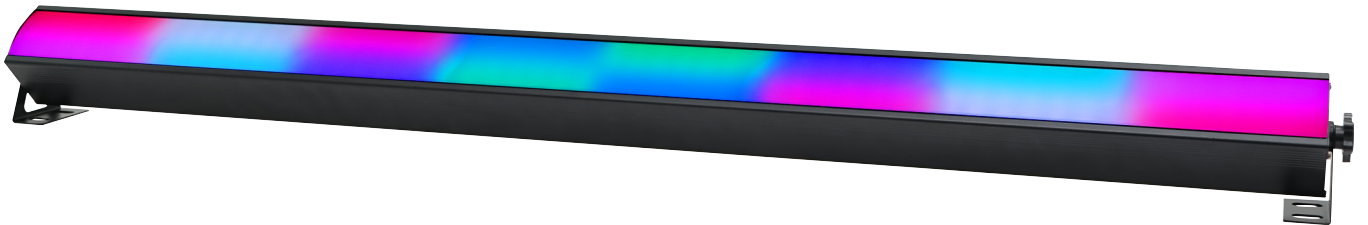

Order code: EQLED055

WARNING

FOR YOUR OWN SAFETY, PLEASE READ THIS USER MANUAL CAREFULLY BEFORE YOUR INITIAL START-UP!

- Before your initial start-up, please make sure that there is no damage caused during transportation.
- Should there be any damage, consult your dealer and do not use the equipment.
- To maintain the equipment in good working condition and to ensure safe operation, it is necessary for the user to follow the safety instructions and warning notes written in this manual.
- Please note that damages caused by user modifications to this equipment are not subject to warranty.



IMPORTANT:

The manufacturer will not accept liability for any resulting damages caused by the non-observance of this manual or any unauthorised modification to the equipment.

- Never let the power cable come into contact with other cables. Handle the power cable and all mains voltage connections with particular caution!
- Never remove warning or informative labels from the unit.
- Do not open the equipment and do not modify the unit.
- Do not connect this equipment to a dimmer pack.
- Do not switch the equipment on and off in short intervals, as this will reduce the system's life.
- Only use the equipment indoors.
- Do not expose to flammable sources, liquids or gases.
- Always disconnect the power from the mains when equipment is not in use or before cleaning! Only handle the power-cable by the plug. Never pull out the plug by pulling the power-cable.
- Make sure that the available mains supply voltage is between 100~240V AC, 50/60Hz.
- Make sure that the power cable is never crimped or damaged. Check the equipment and the power cable periodically.
- If the equipment is dropped or damaged, disconnect the mains power supply immediately and have a qualified engineer inspect the equipment before operating again.
- If the equipment has been exposed to drastic temperature fluctuation (e.g. after transportation), do not connect power or switch it on immediately. The arising condensation might damage the equipment. Leave the equipment switched off until it has reached room temperature.
- If your product fails to function correctly, stop use immediately. Pack the unit securely (preferably in the original packing material), and return it to your Pro Light dealer for service.
- Only use fuses of same type and rating.
- Repairs, servicing and power connection must only be carried out by a qualified technician. THIS UNIT CONTAINS NO USER SERVICEABLE PARTS.
- This lighting fixture is for professional use only - it is not designed for or suitable for household use. The product must be installed by a qualified technician in accordance with local territory regulations. The safety of the installation is the responsibility of the installer. The fixture presents risks of severe injury or death due to fire hazards, electric shock and falls.
- Warning! Risk Group 2 LED product according to EN 62471. Do not view the light output with optical instruments or any device that may concentrate the beam.
- WARRANTY: One year from date of purchase.

OPERATING DETERMINATIONS

If this equipment is operated in any other way, than those described in this manual, the product may suffer damage and the warranty becomes void. Incorrect operation may lead to danger e.g: short-circuit, burns and electric shocks etc.

Do not endanger your own safety and the safety of others!

Incorrect installation or use can cause serious damage to people and/or property.

SpectraPix Batten

The SpectraPix Batten contains 224 SMD 5050 RGB LEDs divided into 16 segments. They feature a wide 120° viewing angle and feature a milky, frost effect front screen along with clear front screen to further expand the versatility of this fixture. Onboard features include colour mixing to create soft washes from its rich colour palette, and chase programs controlled in auto mode or activated by music. A number of chase programs are included and can be selected by the control panel along with speed and variable strobe.

- 224 tri-colour SMD 5050 LEDs (RGB)
- Viewing angle: 120°
- Refresh rate: 2.1kHz
- DMX channels: 3/3/5/24/48 or 53 selectable
- Static colour, auto, sound active and master/slave modes plus built-in programs
- 0-100% dimming and variable strobe
- Bracket allows for multiple rigging or floor standing applications
- 4 push button menu with LED display
- IEC power input/output
- 3-Pin XLR input/output
- Convection cooled

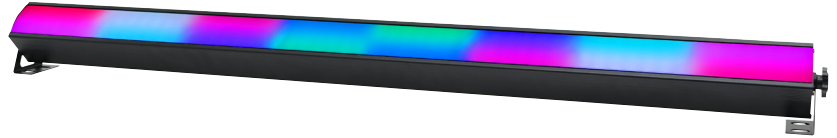

Specifications	
Power consumption	50W
Power supply	100~240V, 50/60Hz
Fuse	F3A 250V
Dimensions	85 x 1035 x 60mm
Weight	1.5kg
Order code	EQLED055

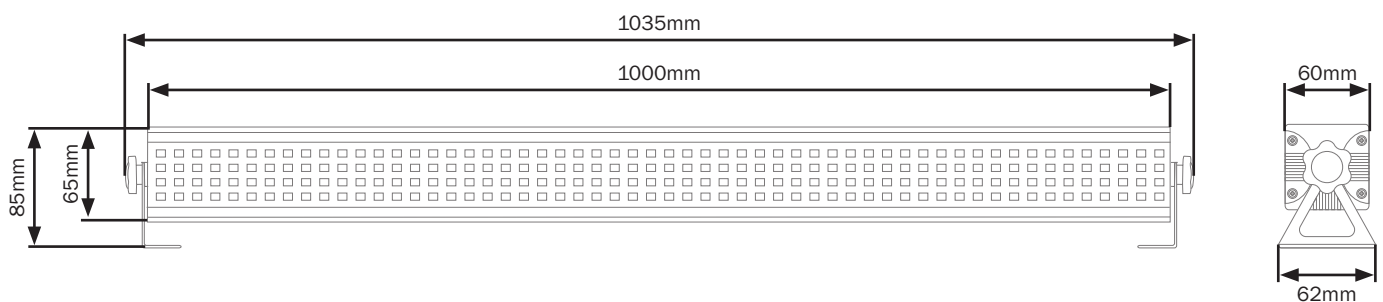

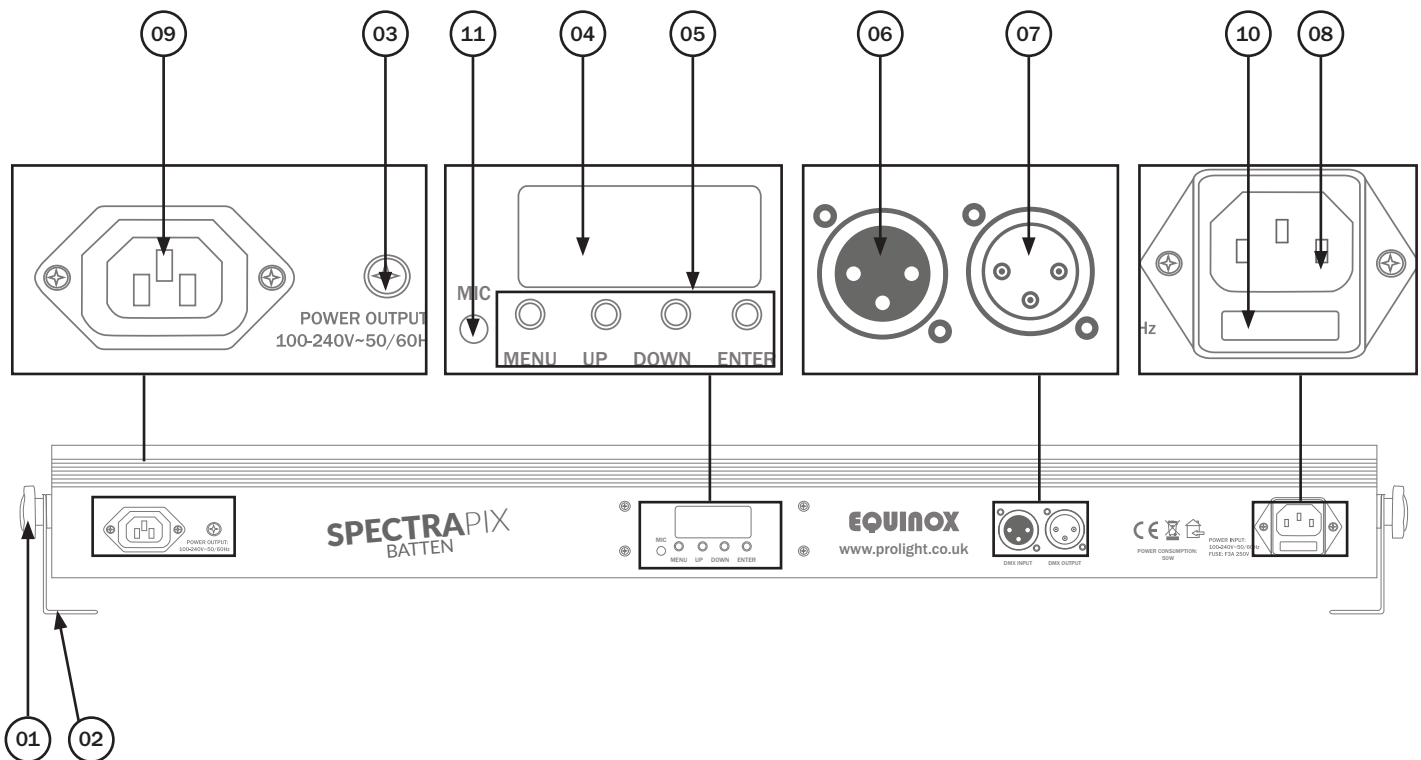

01 - Bracket tightening knobs
 02 - Bracket
 03 - Earth point
 04 - LED display

05 - Function buttons
 06 - 3-Pin XLR input
 07 - 3-Pin XLR output
 08 - IEC power input

09 - IEC power output
 10 - Fuse F3A 250V
 11 - Microphone

In the box:
1 x fixture with frosted front screen,
1 x clear front screen,
2 x mounting brackets/feet and adjustable knobs,
1 x power cable
& 1 x user manual

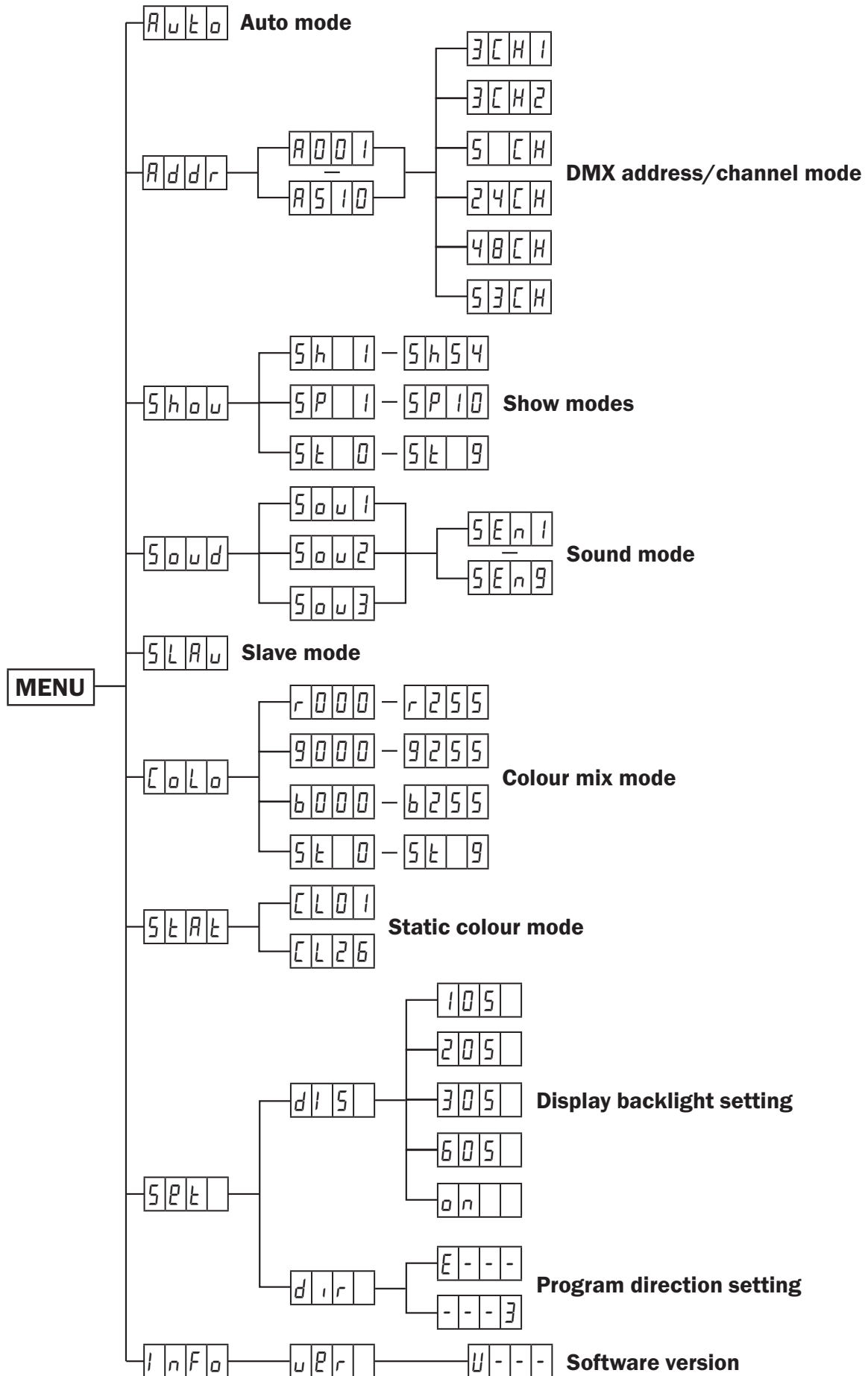

DMX mode:

To access the DMX address mode, press the “MENU” button to show *Addr* on the LED display. Press the “ENTER” button and use the “UP” and “DOWN” buttons to set the required DMX address. Press the “ENTER” button to confirm the setting. Now use the “UP” and “DOWN” buttons to choose one of the 3/3/5/24/48 or 53 DMX channel modes. Press the “ENTER” button to confirm the setting. To exit out of any of the above options, press the “MENU” button.

3 channel mode 1:

Channel	Value	Function
1	000-009	No function
	010-013	Static colour (use channel 2 for colour selection)
	014-017	Built-in program 1
	018-021	Built-in program 2
	022-025	Built-in program 3
	026-029	Built-in program 4
	030-033	Built-in program 5
	034-037	Built-in program 6
	038-041	Built-in program 7
	042-045	Built-in program 8
	046-049	Built-in program 9
	050-053	Built-in program 10
	054-057	Built-in program 11
	058-061	Built-in program 12
	062-065	Built-in program 13
	066-069	Built-in program 14
	070-073	Built-in program 15
	074-077	Built-in program 16
	078-081	Built-in program 17
	082-085	Built-in program 18
	086-089	Built-in program 19
	090-093	Built-in program 20
	094-097	Built-in program 21
	098-101	Built-in program 22
	102-105	Built-in program 23
	106-109	Built-in program 24
	110-113	Built-in program 25
	114-117	Built-in program 26
	118-121	Built-in program 27
122-125	Built-in program 28	
126-129	Built-in program 29	

Channel	Value	Function
1 (cont.)	130-133	Built-in program 30
	134-137	Built-in program 31
	138-141	Built-in program 32
	142-145	Built-in program 33
	146-149	Built-in program 34
	150-153	Built-in program 35
	154-157	Built-in program 36
	158-161	Built-in program 37
	162-165	Built-in program 38
	166-169	Built-in program 39
	170-173	Built-in program 40
	174-177	Built-in program 41
	178-181	Built-in program 42
	182-185	Built-in program 43
	186-189	Built-in program 44
	190-193	Built-in program 45
	194-197	Built-in program 46
	198-201	Built-in program 47
	202-205	Built-in program 48
	206-209	Built-in program 49
	210-213	Built-in program 50
	214-217	Built-in program 51
	218-221	Built-in program 52
	222-225	Built-in program 53
226-229	Built-in program 54	
230-233	Auto mode	
234-237	Sound mode 1	
238-241	Sound mode 2	
242-255	Sound mode 3	
2	000-255	Static colour selection (see list on page 9 for static colours)
3	000-255	Program speed (slow-fast)/ sound sensitivity (low-high)

3 channel mode 2:

Channel	Value	Function
1	000-255	Red (0-100%)
2	000-255	Green (0-100%)
3	000-255	Blue (0-100%)

5 channel mode:

Channel	Value	Function
1	000-255	Master dimmer (0-100%)
2	000-009	No function
	010-255	Strobe (slow-fast)
3	000-255	Red (0-100%)
4	000-255	Green (0-100%)
5	000-255	Blue (0-100%)

24 channel mode:

Channel	Value	Function
1	000-255	Segment 1 red (0-100%)
2	000-255	Segment 1 green (0-100%)
3	000-255	Segment 1 blue (0-100%)
4	000-255	Segment 2 red (0-100%)
5	000-255	Segment 2 green (0-100%)
6	000-255	Segment 2 blue (0-100%)
7	000-255	Segment 3 red (0-100%)
8	000-255	Segment 3 green (0-100%)
9	000-255	Segment 3 blue (0-100%)
10	000-255	Segment 4 red (0-100%)
11	000-255	Segment 4 green (0-100%)
12	000-255	Segment 4 blue (0-100%)
13	000-255	Segment 5 red (0-100%)
14	000-255	Segment 5 green (0-100%)
15	000-255	Segment 5 blue (0-100%)
16	000-255	Segment 6 red (0-100%)
17	000-255	Segment 6 green (0-100%)
18	000-255	Segment 6 blue (0-100%)
19	000-255	Segment 7 red (0-100%)
20	000-255	Segment 7 green (0-100%)
21	000-255	Segment 7 blue (0-100%)
22	000-255	Segment 8 red (0-100%)
23	000-255	Segment 8 green (0-100%)
24	000-255	Segment 8 blue (0-100%)

48 channel mode:

Channel	Value	Function
1	000-255	Segment 1 red (0-100%)
2	000-255	Segment 1 green (0-100%)
3	000-255	Segment 1 blue (0-100%)
4	000-255	Segment 2 red (0-100%)
5	000-255	Segment 2 green (0-100%)
6	000-255	Segment 2 blue (0-100%)
7	000-255	Segment 3 red (0-100%)
8	000-255	Segment 3 green (0-100%)
9	000-255	Segment 3 blue (0-100%)
10	000-255	Segment 4 red (0-100%)
11	000-255	Segment 4 green (0-100%)
12	000-255	Segment 4 blue (0-100%)
13	000-255	Segment 5 red (0-100%)
14	000-255	Segment 5 green (0-100%)
15	000-255	Segment 5 blue (0-100%)
16	000-255	Segment 6 red (0-100%)
17	000-255	Segment 6 green (0-100%)
18	000-255	Segment 6 blue (0-100%)
19	000-255	Segment 7 red (0-100%)
20	000-255	Segment 7 green (0-100%)
21	000-255	Segment 7 blue (0-100%)
22	000-255	Segment 8 red (0-100%)
23	000-255	Segment 8 green (0-100%)
24	000-255	Segment 8 blue (0-100%)
25	000-255	Segment 9 red (0-100%)
26	000-255	Segment 9 green (0-100%)
27	000-255	Segment 9 blue (0-100%)
28	000-255	Segment 10 red (0-100%)
29	000-255	Segment 10 green (0-100%)
30	000-255	Segment 10 blue (0-100%)
31	000-255	Segment 11 red (0-100%)
32	000-255	Segment 11 green (0-100%)
33	000-255	Segment 11 blue (0-100%)
34	000-255	Segment 12 red (0-100%)
35	000-255	Segment 12 green (0-100%)
36	000-255	Segment 12 blue (0-100%)
37	000-255	Segment 13 red (0-100%)
38	000-255	Segment 13 green (0-100%)
39	000-255	Segment 13 blue (0-100%)

48 channel mode (cont.):

Channel	Value	Function
40	000-255	Segment 14 red (0-100%)
41	000-255	Segment 14 green (0-100%)
42	000-255	Segment 14 blue (0-100%)
43	000-255	Segment 15 red (0-100%)
44	000-255	Segment 15 green (0-100%)
45	000-255	Segment 15 blue (0-100%)
46	000-255	Segment 16 red (0-100%)
47	000-255	Segment 16 green (0-100%)
48	000-255	Segment 16 blue (0-100%)

53 channel mode:

Channel	Value	Function
1	000-255	Master dimmer (0-100%)
2	000-009	No function
	010-255	Strobe (slow-fast)
3	000-255	Segment 1 red (0-100%)
4	000-255	Segment 1 green (0-100%)
5	000-255	Segment 1 blue (0-100%)
6	000-255	Segment 2 red (0-100%)
7	000-255	Segment 2 green (0-100%)
8	000-255	Segment 2 blue (0-100%)
9	000-255	Segment 3 red (0-100%)
10	000-255	Segment 3 green (0-100%)
11	000-255	Segment 3 blue (0-100%)
12	000-255	Segment 4 red (0-100%)
13	000-255	Segment 4 green (0-100%)
14	000-255	Segment 4 blue (0-100%)
15	000-255	Segment 5 red (0-100%)
16	000-255	Segment 5 green (0-100%)
17	000-255	Segment 5 blue (0-100%)
18	000-255	Segment 6 red (0-100%)
19	000-255	Segment 6 green (0-100%)
20	000-255	Segment 6 blue (0-100%)
21	000-255	Segment 7 red (0-100%)
22	000-255	Segment 7 green (0-100%)
23	000-255	Segment 7 blue (0-100%)
24	000-255	Segment 8 red (0-100%)
25	000-255	Segment 8 green (0-100%)
26	000-255	Segment 8 blue (0-100%)

53 channel mode (cont.):

Channel	Value	Function
27	000-255	Segment 9 red (0-100%)
28	000-255	Segment 9 green (0-100%)
29	000-255	Segment 9 blue (0-100%)
30	000-255	Segment 10 red (0-100%)
31	000-255	Segment 10 green (0-100%)
32	000-255	Segment 10 blue (0-100%)
33	000-255	Segment 11 red (0-100%)
34	000-255	Segment 11 green (0-100%)
35	000-255	Segment 11 blue (0-100%)
36	000-255	Segment 12 red (0-100%)
37	000-255	Segment 12 green (0-100%)
38	000-255	Segment 12 blue (0-100%)
39	000-255	Segment 13 red (0-100%)
40	000-255	Segment 13 green (0-100%)
41	000-255	Segment 13 blue (0-100%)
42	000-255	Segment 14 red (0-100%)
43	000-255	Segment 14 green (0-100%)
44	000-255	Segment 14 blue (0-100%)
45	000-255	Segment 15 red (0-100%)
46	000-255	Segment 15 green (0-100%)
47	000-255	Segment 15 blue (0-100%)
48	000-255	Segment 16 red (0-100%)
49	000-255	Segment 16 green (0-100%)
50	000-255	Segment 16 blue (0-100%)
51	000-009	No function
	010-013	Static colour (use channel 2 for colour selection)
	014-017	Built-in program 1
	018-021	Built-in program 2
	022-025	Built-in program 3
	026-029	Built-in program 4
	030-033	Built-in program 5
	034-037	Built-in program 6
	038-041	Built-in program 7
	042-045	Built-in program 8
	046-049	Built-in program 9
	050-053	Built-in program 10
	054-057	Built-in program 11
058-061	Built-in program 12	

53 channel mode (cont.):

Channel	Value	Function
51 (cont.)	062-065	Built-in program 13
	066-069	Built-in program 14
	070-073	Built-in program 15
	074-077	Built-in program 16
	078-081	Built-in program 17
	082-085	Built-in program 18
	086-089	Built-in program 19
	090-093	Built-in program 20
	094-097	Built-in program 21
	098-101	Built-in program 22
	102-105	Built-in program 23
	106-109	Built-in program 24
	110-113	Built-in program 25
	114-117	Built-in program 26
	118-121	Built-in program 27
	122-125	Built-in program 28
	126-129	Built-in program 29
	130-133	Built-in program 30
	134-137	Built-in program 31
	138-141	Built-in program 32
	142-145	Built-in program 33
	146-149	Built-in program 34
	150-153	Built-in program 35
	154-157	Built-in program 36
	158-161	Built-in program 37
	162-165	Built-in program 38
	166-169	Built-in program 39
	170-173	Built-in program 40
	174-177	Built-in program 41
	178-181	Built-in program 42
	182-185	Built-in program 43
	186-189	Built-in program 44
190-193	Built-in program 45	
194-197	Built-in program 46	
198-201	Built-in program 47	
202-205	Built-in program 48	
206-209	Built-in program 49	
210-213	Built-in program 50	
214-217	Built-in program 51	

Channel	Value	Function
51 (cont.)	214-217	Built-in program 51
	218-221	Built-in program 52
	222-225	Built-in program 53
	226-229	Built-in program 54
	230-233	Auto mode
	234-237	Sound mode 1
	238-241	Sound mode 2
	242-255	Sound mode 3
52	000-255	Static colour selection (see list on page 9 for static colours)
53	000-255	Program speed (slow-fast)/ sound sensitivity (low-high)

Static colours

Value	Colour
000-009	No function
010-019	Red
020-029	Dark Orange
030-039	Orange
040-049	Amber
050-059	Yellow
060-069	Yellow Green
070-079	Lime Green
080-089	Medium Green
090-099	Green
100-109	Vibrant Green
110-119	Mint Green
120-129	Turquoise

Value	Colour
130-139	Cyan
140-149	Light Blue
150-159	Medium Blue
160-169	Congo Blue
170-179	Blue
180-189	Purple Blue
190-199	Purple
200-209	Violet
210-219	Pink
220-229	Magenta
230-239	Hot Pink
240-249	Fuchsia
250-255	White (RGB)

Auto mode:

To access auto mode, press the “MENU” button to show *AUTO* on the LED display. Now press the “ENTER” button, the Auto mode will now run. Press the “ENTER” button to confirm the setting.

Show modes (built-in programs):

To access the show modes (built-in programs), press the “MENU” button to show *Show* on the LED display. Now press the “ENTER” button and use the “UP” and “DOWN” buttons to choose the required program *Sh 1 ~ Sh 54*. Press the “ENTER” button and use the “UP” and “DOWN” buttons to select the speed between *SP 1 ~ SP 10*. Press the “ENTER” button to confirm the setting and use the “UP” and “DOWN” buttons to select the flash speed between *St 0 ~ St 9*.

Press the “ENTER” button to confirm the setting.

To exit out of any of the above options, press the “MENU” button.

Sound modes:

To access the sound modes (built-in programs), press the “MENU” button to show *Sound* on the LED display. Now press the “ENTER” button and use the “UP” and “DOWN” buttons to choose the required sound mode *Sou 1 ~ Sou 3*. Press the “ENTER” button and use the “UP” and “DOWN” buttons to select the sound sensitivity between *SEn 1 ~ SEn 9*.

Press the “ENTER” button to confirm the setting.

To exit out of any of the above options, press the “MENU” button.

Colour mix mode:

To access the static colour mode press “MENU” until *COLO* shows on the LED display.

Now press the “ENTER” button and use the “UP” and “DOWN” buttons to select the brightness between *r.000 ~ r.255*. Press the “ENTER” button and repeat for green (*g*) and blue (*b*).

Value: 000 - 255 (000 = low brightness, 255 = high brightness)

To exit out of any of the above options, press the “MENU” button.

Static colour mode:

To access the static colour mode, press the “MENU” button to show *StAL* on the LED display.

Now press the “ENTER” button and use the “UP” and “DOWN” buttons to choose the required colour between *CL01 ~ CL26*. Press the “ENTER” button to confirm the setting.

To exit out of any of the above options, press the “MENU” button.

Value	Colour
CL01	Blackout
CL02	Red
CL03	Dark Orange
CL04	Orange
CL05	Amber
CL06	Yellow
CL07	Yellow Green
CL08	Lime Green

Value	Colour
CL08	Lime Green
CL09	Medium Green
CL10	Green
CL11	Vibrant Green
CL12	Mint Green
CL13	Turquoise
CL14	Cyan
CL15	Light Blue

Value	Colour
CL16	Medium Blue
CL17	Congo Blue
CL18	Blue
CL19	Purple Blue
CL20	Purple
CL21	Violet
CL22	Pink
CL23	Magenta

Value	Colour
CL24	Hot Pink
CL25	Fuchsia
CL26	White (RGB)

Master/slave mode:

The default setting for this fixture is master. To set the master unit, select from one of the auto, show, sound, colour mix or static colour modes.

To set the slave unit, press the “MENU” button to show *SLAVE* on the LED display.

The unit is now in slave mode. To exit out of any of the above options, press the “MENU” button.

Please ensure that all slave units are set to the same DMX channel mode as the master unit.

Software version:

To view the fixtures software version, press the “MENU” button to show *INFO* on the LED display.

Now press the “ENTER” button to show *VER*, press the “ENTER” button again and the software version will be displayed. To exit out of any of the above options, press the “MENU” button.

Please ensure that all slave units are set to the same DMX channel mode as the master unit.

Display backlight setting:

To access the display backlight setting, press the “MENU” button to show *SET* on the LED display. Now press the “ENTER” button and use the “UP” and “DOWN” buttons to select *DIS*. Press the “ENTER”

button and use the “UP” and “DOWN” buttons to select between *10 S* (10 seconds), *20 S* (20 seconds), *30 S* (30 seconds), *60 S* (60 seconds) or *ON* (constantly on).

Press the “ENTER” button to confirm the setting.

To exit out of any of the above options, press the “MENU” button.

Program direction setting:

To access the program direction setting, press the “MENU” button to show *SET* on the LED display.

Now press the “ENTER” button and use the “UP” and “DOWN” buttons to select *DIR*. Press the “ENTER” button and use the “UP” and “DOWN” buttons to select between *E - - -* or *- - - E*.

Press the “ENTER” button to confirm the setting.

To exit out of any of the above options, press the “MENU” button.

Setting the DMX address:

The DMX mode enables the use of a universal DMX controller. Each fixture requires a “start address” from 1- 512. A fixture requiring one or more channels for control begins to read the data on the channel indicated by the start address. For example, a fixture that occupies or uses 7 channels of DMX and was addressed to start on DMX channel 100, would read data from channels: 100, 101, 102, 103, 104, 105 and 106. Choose a start address so that the channels used do not overlap. E.g. the next unit in the chain starts at 107.

DMX 512:

DMX (Digital Multiplex) is a universal protocol used as a form of communication between intelligent fixtures and controllers. A DMX controller sends DMX data instructions from the controller to the fixture. DMX data is sent as serial data that travels from fixture to fixture via the DATA “IN” and DATA “OUT” XLR terminals located on all DMX fixtures (most controllers only have a data “out” terminal).

DMX linking:

DMX is a language allowing all makes and models of different manufactures to be linked together and operate from a single controller, as long as all fixtures and the controller are DMX compliant. To ensure proper DMX data transmission, when using several DMX fixtures try to use the shortest cable path possible. The order in which fixtures are connected in a DMX line does not influence the DMX addressing. For example; a fixture assigned to a DMX address of 1 may be placed anywhere in a DMX line, at the beginning, at the end, or anywhere in the middle. When a fixture is assigned a DMX address of 1, the DMX controller knows to send DATA assigned to address 1 to that unit, no matter where it is located in the DMX chain.

DATA cable (DMX cable) requirements (for DMX operation):

This fixture can be controlled via DMX-512 protocol. The DMX address is set on the back of the unit. Your unit requires either a standard 3-pin or 5-pin XLR connector for data input/output, see images below.



Further DMX cables can be purchased from all good sound and lighting suppliers or Prolight Concepts dealers.

Please quote:	3-Pin:	CABL10 – 2m	CABL11 – 5m	CABL12 – 10m
	5-Pin:	CABL185 – 2m	CABL187 – 5m	CABL188 – 10m

Also remember that DMX cable must be daisy chained and cannot be split.

Notice:

Be sure to follow the diagrams below when making your own cables. Do not connect the cables shield conductor to the ground lug or allow the shield conductor to come in contact with the XLRs outer casing. Grounding the shield could cause a short circuit and erratic behaviour.

Pin Configuration	
3-Pin	5-Pin
	Pin 1 - Ground
	Pin 2 - Negative
	Pin 3 - Positive
-	Pin 4 - N/C
-	Pin 5 - N/C

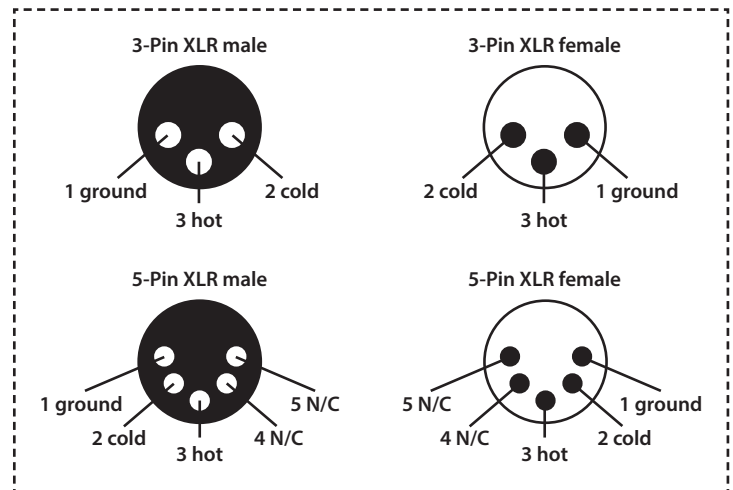
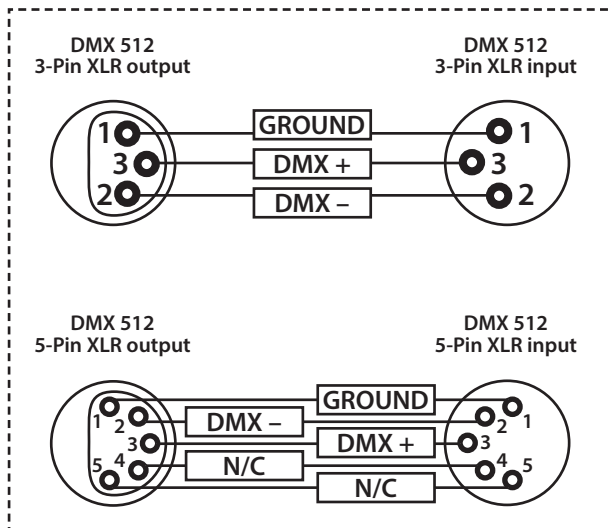

Line termination:

When longer runs of cable are used, you may need to use a terminator on the last unit to avoid erratic behaviour.

Using a cable terminator will decrease the possibilities of erratic behaviour.

(3-pin - Order ref: CABL90,
5-pin - Order ref: CABL89)

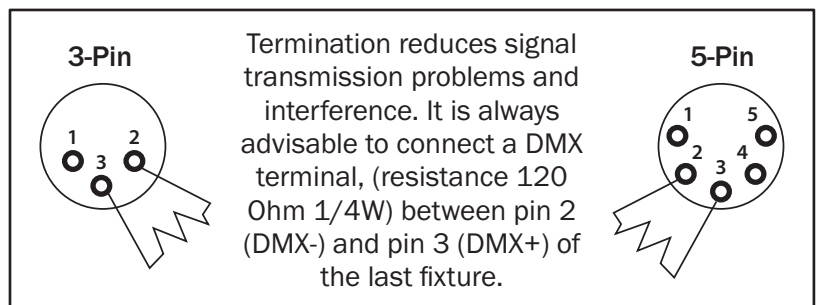

5-pin XLR DMX connectors:

Some manufactures use 5-pin XLR connectors for data transmission in place of 3-pin. 5-pin XLR fixtures may be implemented in a 3-pin XLR DMX line. When inserting standard 5-pin XLR connectors in to a 3-pin line a cable adaptor must be used. The diagram below details the correct cable conversion.

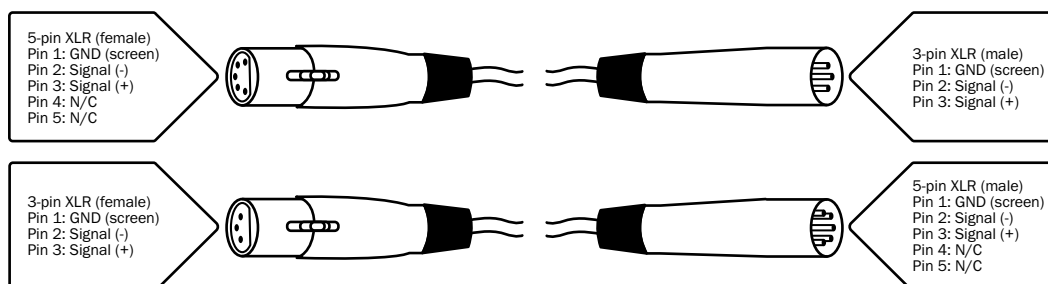

Power linking:

This fixture provides power linking via the power output on the rear allowing multiple units to be connected together. The maximum number of fixtures that can be connected is 16 fixtures @ 240V or 8 fixtures @ 120V (including the first fixture). After the maximum number of fixtures are connected a new power run will need to be started.

Please note: Caution should be used when power linking other fixtures to the SpectraPix Batten as the power consumption of other fixtures will vary. Fixtures fitted with lamps often require 2/3 times more current on startup, these may require their own power source.





Correct Disposal of this Product (Waste Electrical & Electronic Equipment)

**(Applicable in the European Union and other European countries
with separate collection systems)**



This marking shown on the product or its literature, indicates that it should not be disposed of with other household wastes at the end of its working life. To prevent possible harm to the environment or human health from uncontrolled waste disposal, please separate this from other types of wastes and recycle it responsibly to promote the sustainable reuse of material resources.

Household users should contact either the retailer where they purchased this product, or their local government office, for details of where and how they can take this item for environmentally safe recycling.

Business users should contact their supplier and check the terms and conditions of the purchase contract. This product should not be mixed with other commercial wastes for disposal.